

***... an organization is the
lengthened shadow of
one man ...***

Ralph Waldo Emerson





UKH Linz 20

Omnipraesenz
Emotionales Lernen
Kultur der schriftlichen
Dokumentation
Liebe zum Detail
Atraumatisches Operieren

***These two functions,
emotion and memory, are
so closely coupled that
one cannot fully
understand the latter
without the former***

***Antonio Damasio: Unity of Knowledge
2000***

***Kritisiert zu werden ist ein
Privileg***
Reinhart Höhn

Omnipraesenz
Emotionales Lernen
Kultur der schriftlichen
Dokumentation
Liebe zum Detail
Atraumatisches Operieren

***Was machst Du nach dem
Operieren?***

***Das Wichtigste ist sich Zeit zu
nehmen darüber
nachzudenken, was man in
Zukunft besser machen kann.***

Rudolf Strelt



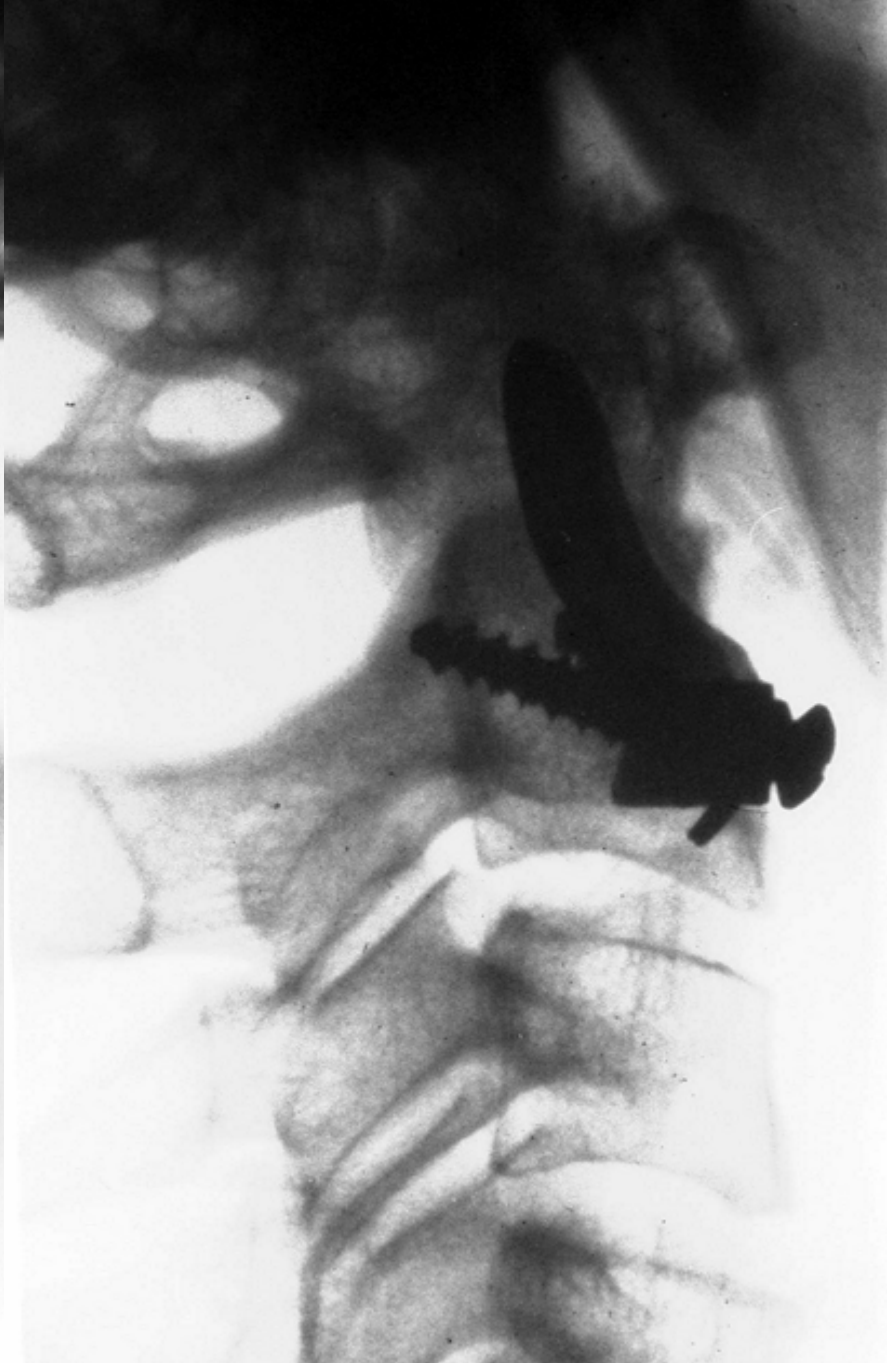

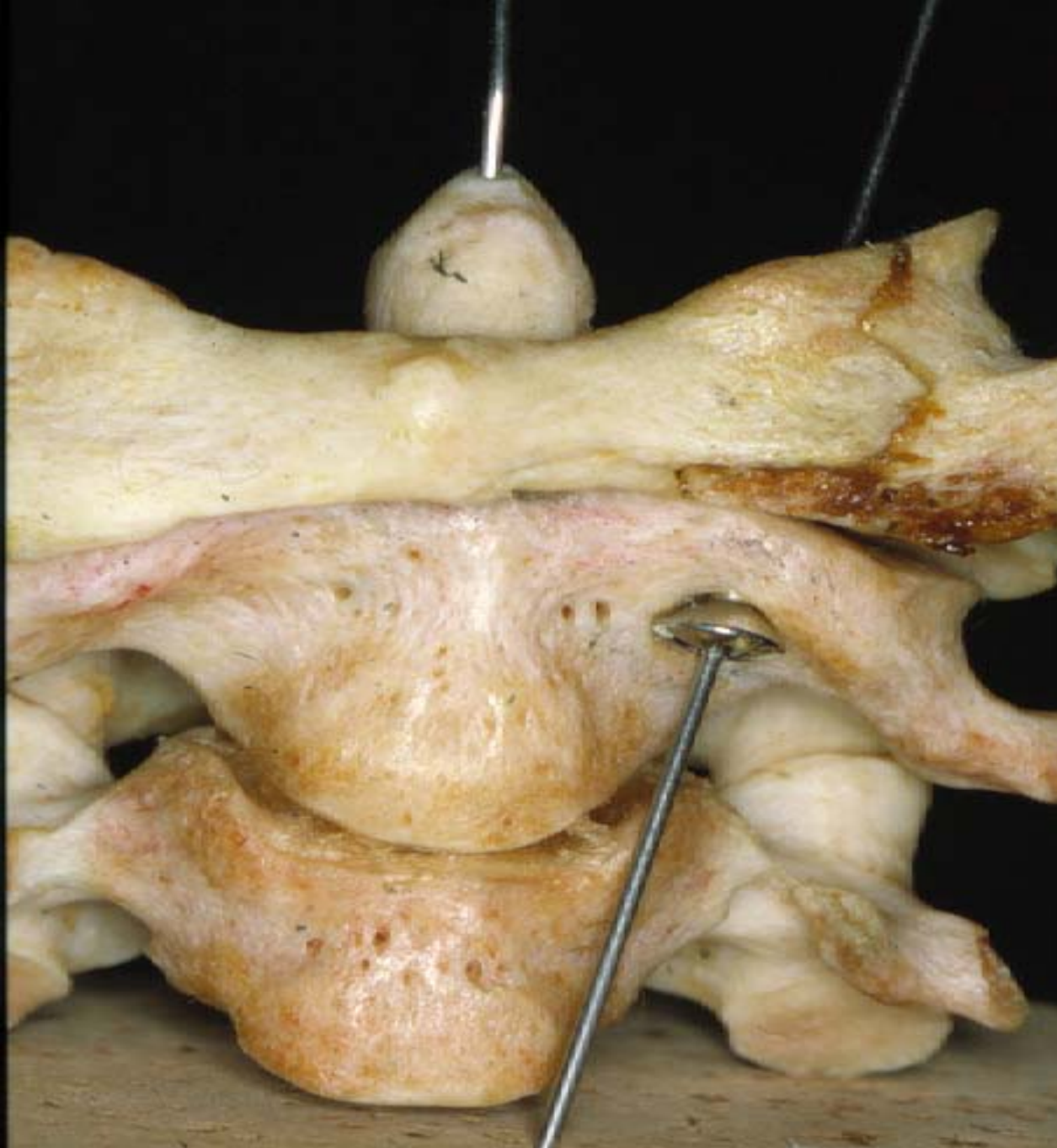



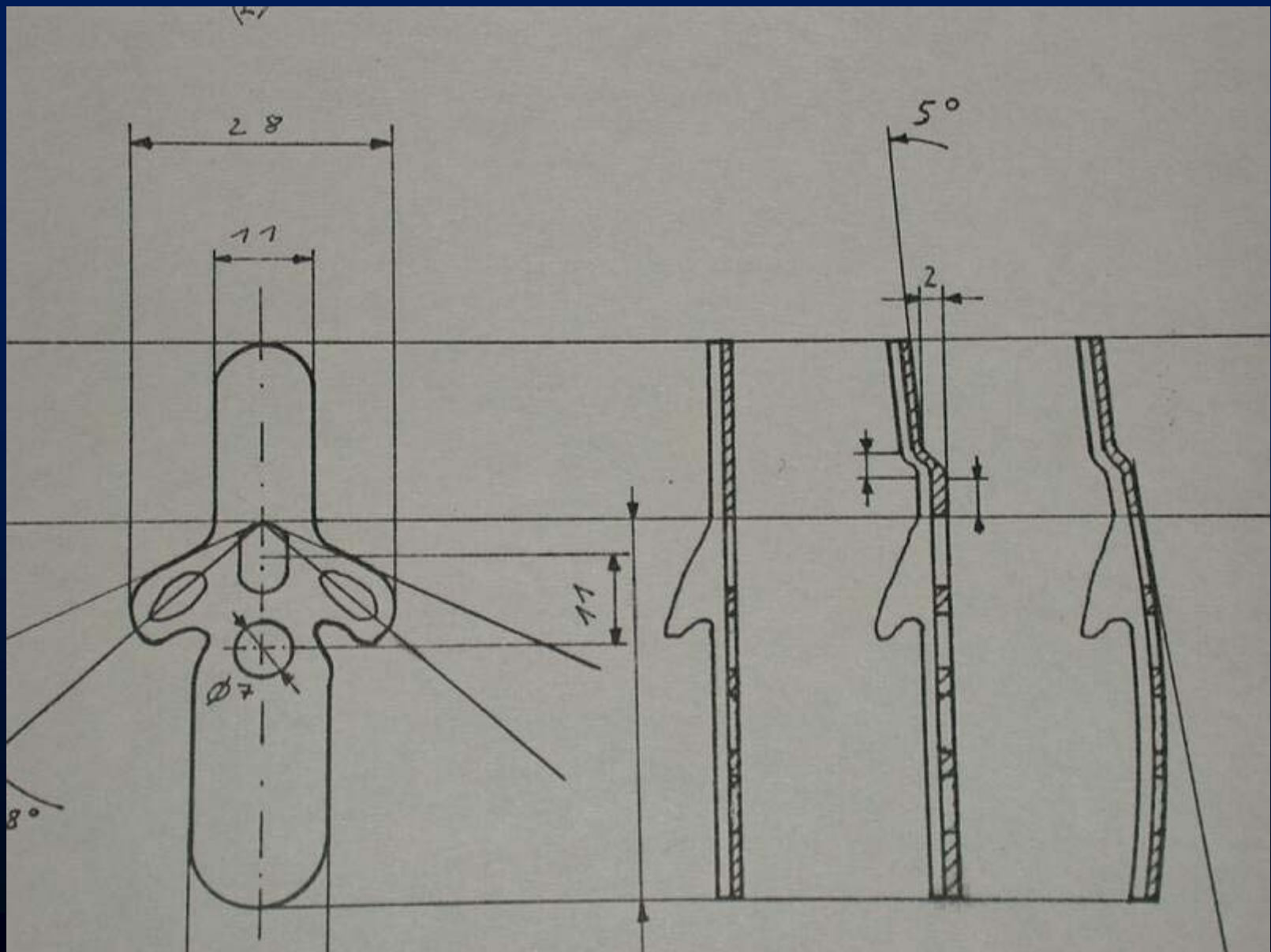













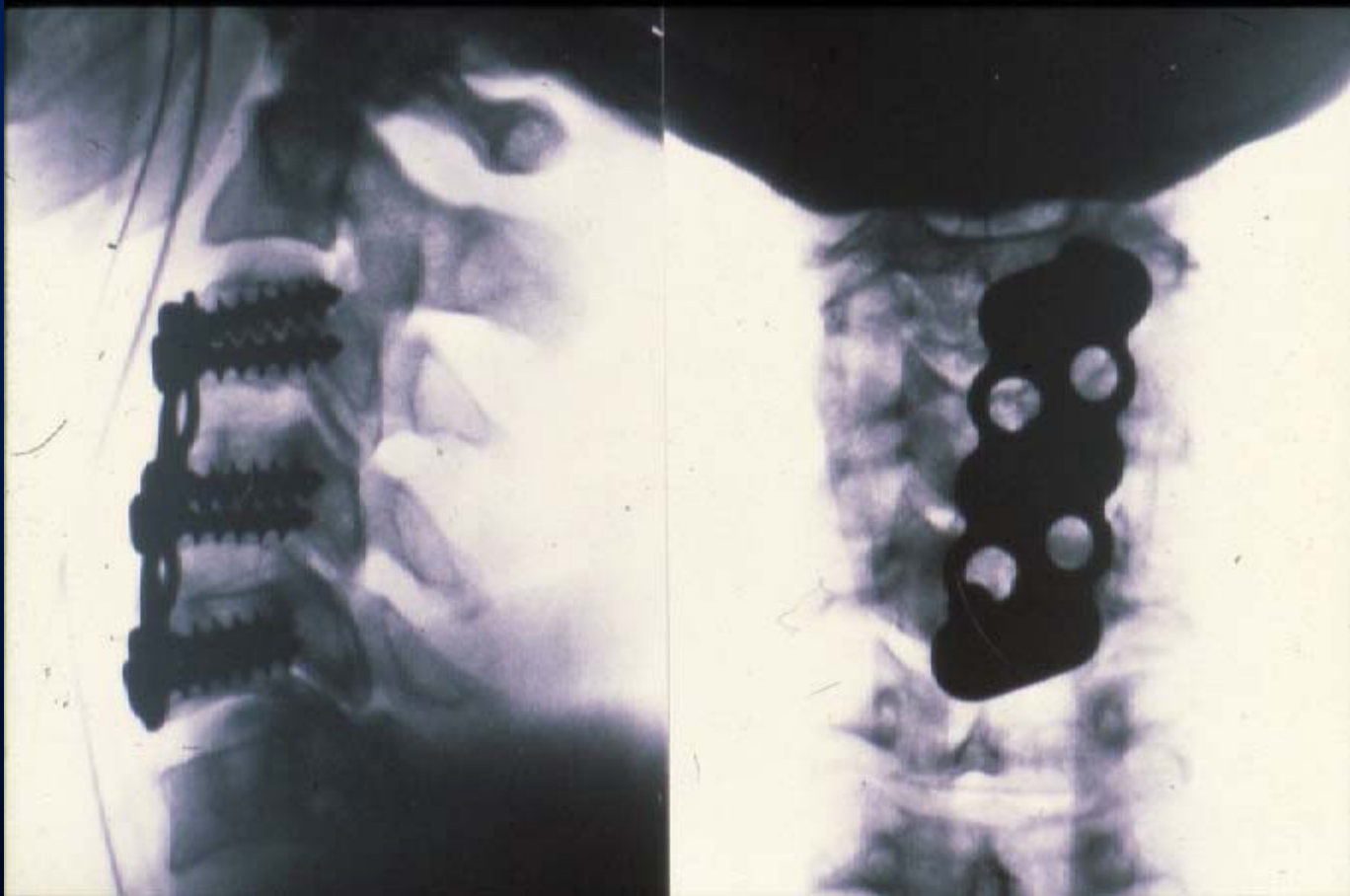

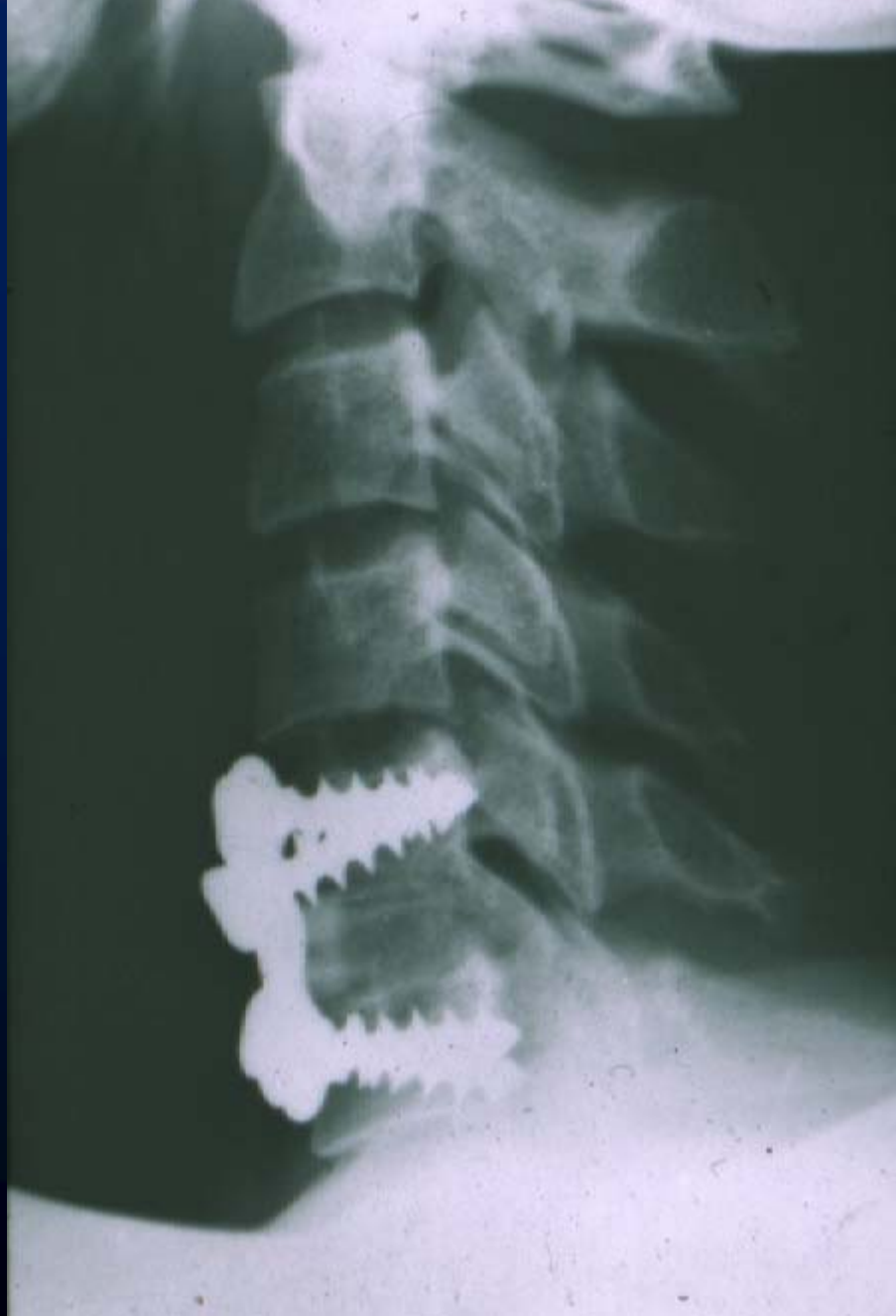







The Probe and Learn Process
The Improvement Process
Randomisierte Kontrollierte
Studie

The Probe and Learn Process

Create Prototypes

Collect feedback from the patients

Expect to revise repeatedly

*Employ a comprehensive
measurement package*

Know when to stop

David A Garvin (Harvard 2000)



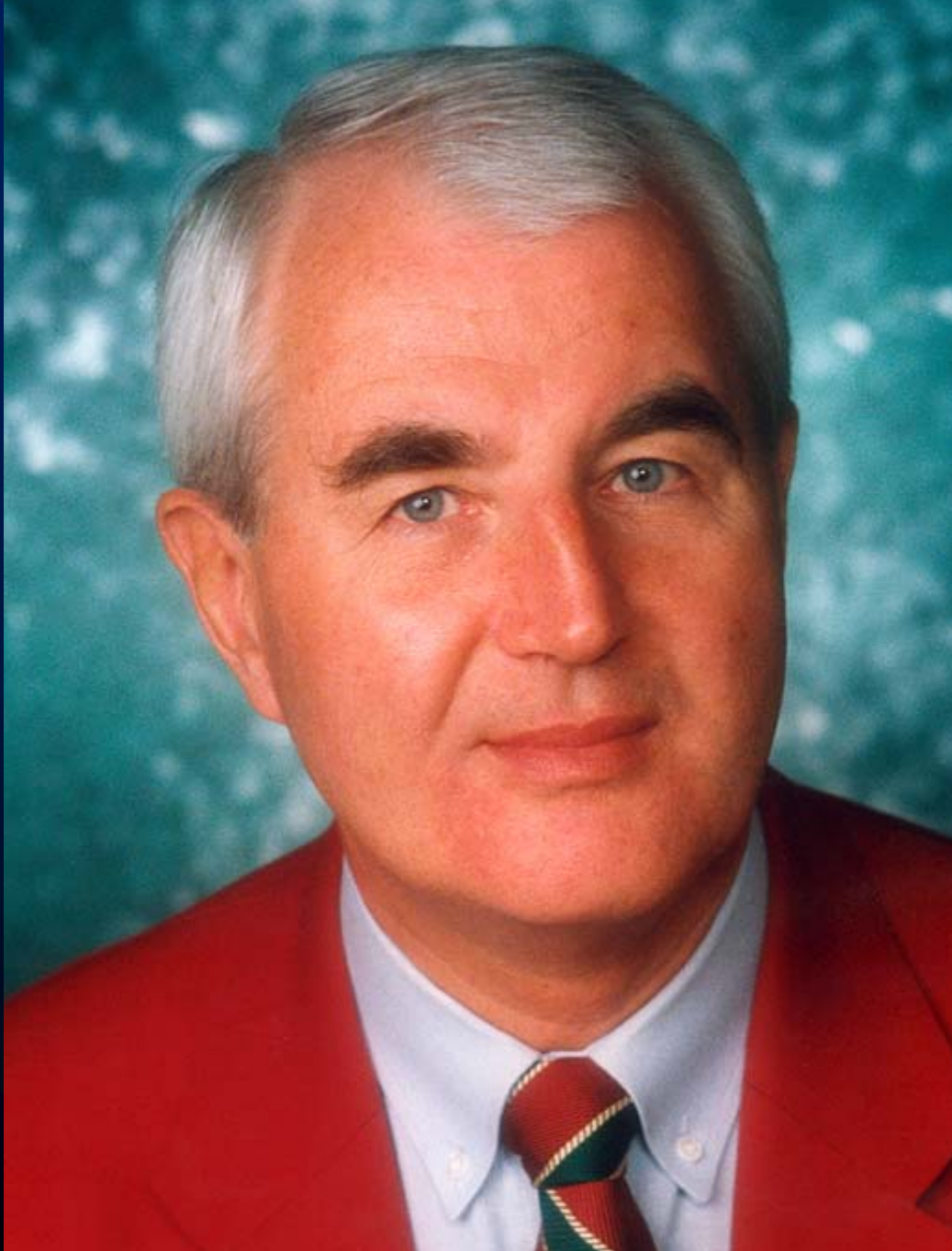

UKH Linz 20

***Kultur der mündlichen
Kommunikation***

Emotionalität

Integrität gegenüber den Patienten

Spezialambulanzen

***The first task of a leader is to
define reality***
Harvey Golub



... Die Erlebnisse eines Menschen mit der Zeit zu den persönlichen Erinnerungen Vieler werden und zur Ergänzung dessen wird, was am eigenen Leben fehlt.

Macauley

***Kultur der mündlichen
Kommunikation***

Emotionalität

Integrität gegenüber den Patienten

Spezialambulanzen

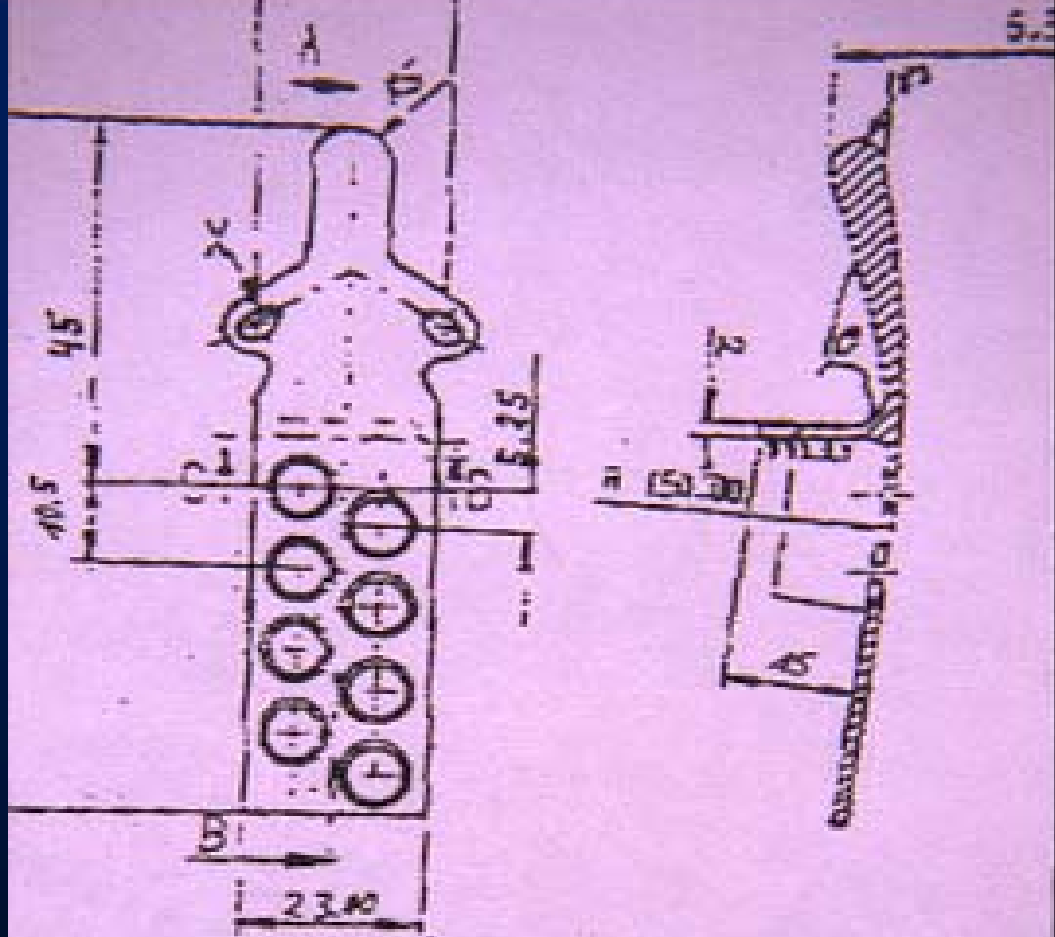

Ans: attached
 4.9.91

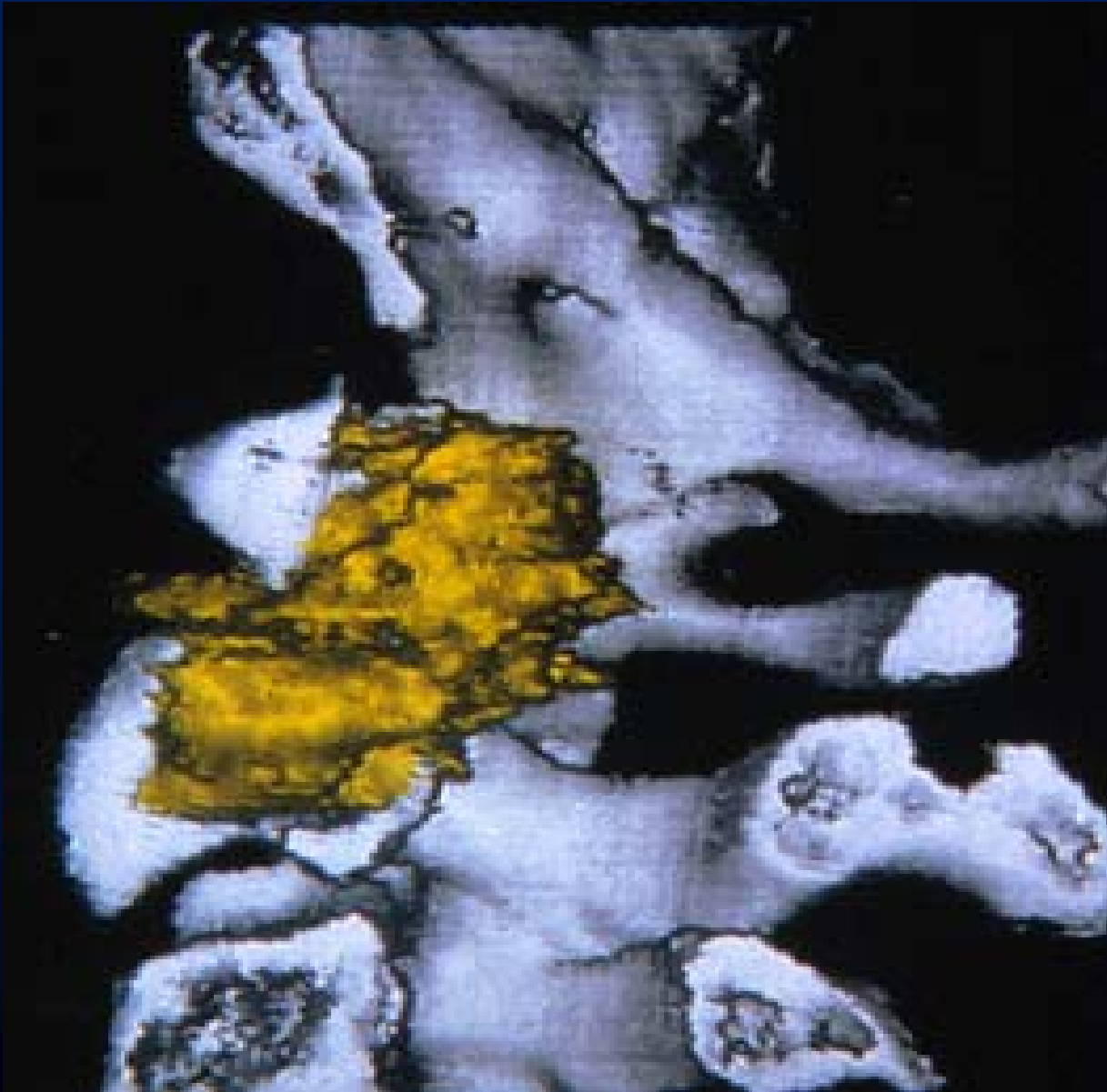



F.H. 67a w 23.9.91

***Remember we see so far,
because we stand
on the shoulders of giants.***

Sir Isaak Newton

